

■ GEBERIT

GEBERIT CARES

GEBERIT AQUACLEAN MERA CARE.

INNOVATIVE THINKING
FOR INDEPENDENT LIVING



**5 YEAR
WARRANTY**

FREE 5 years parts and labour
when you register your product
geberit-aquaclean.co.uk/care

WE ARE COMMITTED TO THE HIGHEST POSSIBLE STANDARDS IN INDEPENDENT CARE. YOURS

Geberit cares about innovation in independent living. By understanding the OT's and end user requirements we are able to offer an unrivalled package that will make you feel confident you are choosing the right product.

- Designed with aesthetics and function at its core
- Designed and adapted specifically for the needs of the care market
- A specialist sales team who understand the market
- We understand that the budget is important
- Easy personalised settings - no need for an engineer to be called out
- 5 year guarantee and 25 year parts stocking guarantee for internal cistern working parts

WATER - THE NATURAL WAY TO CLEAN

05 DEVELOPED FOR INDEPENDENT LIVING

Find out more about how we have spent the past 40 years investing in the development of shower toilet technology.



06 SWISS PRECISION

Our pioneering shower toilet is designed to put you in control in the bathroom.

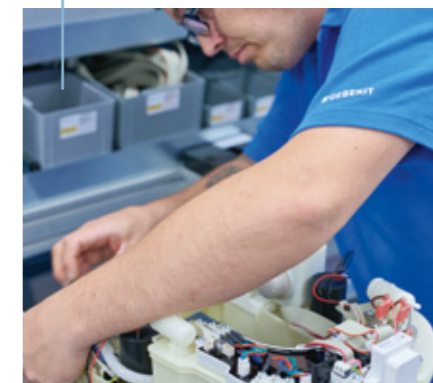

07 THE ASSESSMENT

We'll discuss your home needs plus you get the chance to try before you buy.



08-09 CREATING INDEPENDENT SPACES

We want to help restore your independence and maintain your dignity by giving you the tools you need.

10-11 PERSONAL PROGRAMME & THE AQUACLEAN APP

12-13 FEATURES AND BENEFITS

Specially developed for the care sector, with features tailored to your needs.

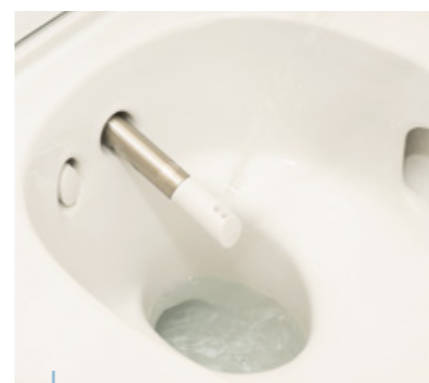

14 - FEATURES

15 We've upgraded our toilet to have more functions than ever! Find out more about them and how best to use them.



16 ACCESSORIES



- 17 FAQs
- 18 WARRANTY
- 20 ADVICE AND SERVICE
- 21 RESOURCES
- 22 FEATURES AT A GLANCE
- 23 TECHNICAL INFORMATION
- 24 SPEC SHEET

INDEPENDENCE IN THE HOME, AND PARTICULARLY THE BATHROOM, IS NEVER AN EASY SUBJECT TO TACKLE. FROM THE STIGMA OF 'INSTITUTIONAL' LOOKING SUPPORT AIDS TO THE COMPLEXITIES AND INCONSISTENCIES OF THE ASSESSMENT AND FUNDING PROCESS, IT CAN OFTEN BE A LONG AND CHALLENGING JOURNEY.

AT THE HEART OF THE ISSUE, HOWEVER, REMAINS A VITALLY IMPORTANT QUESTION; HOW CAN WE SUPPORT PEOPLE TO LIVE INDEPENDENTLY WITHOUT COMPROMISING THEIR DIGNITY?

Whilst there is no magic wand to funding or red tape, with greater education, enhanced visibility of key solutions and a more collaborate approach, I believe it is possible to close the gaps between identifying a need and installing those solutions which can literally change lives.

The Geberit AquaClean Mera Care in every aspect, and at all levels of product development, we have focused on the needs of the end users – and the new five-year warranty underscores our confidence in what is a new generation product for the shower toilet market. Thanks to its outstanding functionality, this new product is not only beautiful to look at, it also makes life easier and more comfortable for the user.

Simon Thomas
National AquaClean Care Sales Director

THE GEBERIT AQUACLEAN MERA CARE DEVELOPED FOR INDEPENDENT LIVING

The Geberit AquaClean Mera Care shower toilet is designed to put you in control.

Its innovative features include a hybrid hot water system with continuous flow heater and a water storage heater that guarantees warm water even if the wash is run one after another. The one minute wash cycle draws from the warmed tank of water and the continuous flow heater on the first use, this can be followed by another minute of wash with warm water directly from the continuous flow heater, whilst the water storage tank refills. Thanks to this technology you'll always have a warm water wash and the confidence to feel clean. Warm air drying will leave you clean and fresh, along with a single activation control panel for ease of use. Everything is designed with your comfort and convenience in mind.

Our development team have been working on the Geberit AquaClean Mera Care design for independent living for several years, utilising the Geberit Group's experience and expertise. We are constantly evolving and enhancing every aspect of our care products and have installed a number of these units across the UK during the development phase to test their installation and use, and to seek feedback, so we were able to make any enhancements required.



SWISS PRECISION AND INNOVATION

WE HAVE SPENT 40 YEARS INVESTING IN THE DEVELOPMENT OF SHOWER TOILET TECHNOLOGY FINE-TUNING OUR PRODUCTS TO ABSOLUTE PERFECTION. THE RESULT? THE GEBERIT AQUACLEAN.

Over the last 40 years at the Geberit headquarters in Rapperswil-Jona, Switzerland, we have invested a wealth of experience and expertise in development work for the shower toilet technology, with each new shower toilet our technology develops and we are able to offer something else new and innovative.

Armin Gierer, Head of the Geberit AquaClean product range, expresses the philosophy behind our pioneering work: 'When it comes to the development of our Geberit AquaClean shower toilets, we do not compromise on comfort and well-being. The calm, aesthetic design is based on a ground-breaking product concept and offers revolutionary, innovative technologies. Functionality, cleanliness and sustainability which set standards.'



"The revolutionary patented features are the result of a process of constantly perfecting that technology so it provides sophisticated Swiss precision in all of its functions, along with finely-tuned performance, comfort and convenience."

ARMIN GIERER
HEAD OF THE GEBERIT AQUACLEAN PRODUCT RANGE

THE ASSESSMENT

At Geberit we take pride, time and effort in ensuring all our clients have the opportunity to view a fully functioning demonstration toilet in their own home prior to any adaptations or installation work.

Giving the client the opportunity to interact with a shower toilet, to hear the different sounds, feel the warmth from the dryer and to engage with the various control options is a powerful and rewarding experience. Helping to remove anxieties, concerns or even worries about the kind of equipment you as an Occupational Therapist, Technical Office, Surveyor or Grants Officer may be wishing to provide.

A home assessment also gives opportunities for discussion in the bathroom regarding future proofing, seat heights, compatible equipment and activity analysis. At every home assessment a Geberit CARE Team member completes their assessment notes, this is a complete guide/ breakdown of what work is needed in the bathroom and instructions to help you better process your adaptation request.

All our CARE team members carry a fully working demonstration toilet in their vehicles. All our vehicles are equipped with hoists to ensure each assessment is completed safely and our team members can complete their visit with confidence.

THE BENEFITS OF A PRODUCT ASSESSMENT

- Face to face product demonstration
- Hands on opportunity for the client
- Familiarisation of controls
- Client confidence building
- Offers OT the chance to observe the client using all the controls & functions (Activity Analysis)
- Provides an opportunity for clients to ask questions about the product
- Alleviate any concerns or anxieties



CREATING INDEPENDENT SPACES

THE GEBERIT AQUACLEAN MERA CARE SHOWER TOILET PUTS YOU IN CONTROL

The Geberit AquaClean Mera Care shower toilet has been specifically designed to put you in control, giving you confidence and independence in the bathroom. Smart, stylish and easy to use, its advanced technology enables you to have a greater sense of independence in the bathroom.

Geberit innovation brings together a range of innovative features in the AquaClean Mera Care, cleverly designed and adapted to take care of your individual needs and to put you in control. You'll feel cleaner and fresher with a comfortable, convenient and hygienic bathroom experience.



CHILDREN AND YOUNG ADULTS

Shower toilets are not just for adults. Over the decades, the AquaClean CARE shower toilet has been proven to work effectively with children and young adults. It helps promote personal independence, eliminates embarrassing situations, and boosts morale and confidence.

The AquaClean CARE shower toilet is also highly compatible with leading brands of pediatric shower chairs, including the Jiraffe Rifton HTS, RAZ ATP, R82 Flamingo and Heron, as well as the Prism Medical T90 and T80 Auto Paediatric ranges.

Having the ability to adjust the power of the wash benefits users who may be nervous or unsettled by changes in their habits. For example, a young autistic person may initially find the wash an unusual experience. The ability to adjust the power of the wash allows them to start with a gentle, less unsettling wash. Over time, as the sensation of washing with water becomes more familiar, they can increase the power of the wash to achieve a more effective clean. The same applies to the dryer function. Being able to turn the dryer on or off, as well as adjust the speed and temperature, gives those who might initially feel nervous or unsettled the control to tailor the experience to their comfort level. This step-by-step approach helps them gradually incorporate shower toileting into their daily routine.

The AquaClean CARE shower toilet offers remarkable flexibility, adapting seamlessly to the evolving needs of children and young adults. This adaptability ensures that as they grow, their personal care remains consistent and tailored to their requirements. Integrating modern design and technology, the AquaClean CARE allows users to control the toilet via the Geberit Home app on their mobile phones. For those with severe disabilities, the integration of eye gaze technology on iPads and tablets provides an empowering solution, enabling independent control over wash and dry functions, thereby enhancing dignity and autonomy in personal care.



YOUR PERSONAL WELL-BEING PROGRAMME

EVERYTHING PERFECTLY TAILORED AND CUSTOMISED TO YOUR REQUIREMENTS

Every person has unique requirements, which is why the Geberit AquaClean Mera Care can be adjusted, from the position of the spray arm to the water temperature and intensity, right through to the dryer setting. Geberit AquaClean is an ideal solution for most living situations.

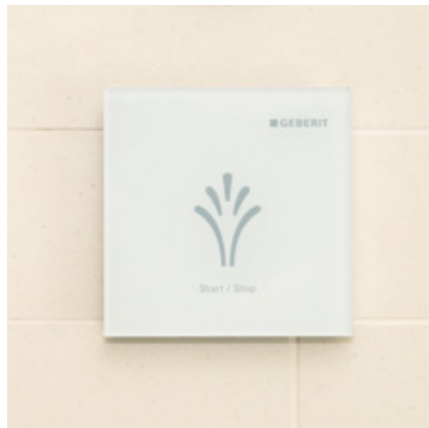

↑ TOUCH-FREE OPERATION

With the touchless remote, using the Geberit AquaClean Mera Care can be completely hands-free. A sensor detects movement and automatically starts the washing and drying sequence. All functions will only operate when you are seated. It will even flush the shower toilet automatically before the wash cycle – easy, private and convenient.



↑ PERSONALISED COMFORT

With the enhanced memory function on the remote control, you can select your own programme and store it, so that it can be used again and again. For added convenience, once saved the settings can be activated by the opto-remote or control panel. The remote also includes a button for flushing.



↑ TOTAL CONTROL

The wash and dry cycle can be easily activated by either the push-button control panel located to the side of the toilet, or the remote control, providing you with maximum control.



↑ ADJUSTABLE HEIGHT

Geberit AquaClean Mera Care (with a height range of 435mm-565mm) is flexible to accommodate specific seat height requirements at installation, thanks to the in-built height adjustable stainless steel frame.



↑ ASSESSMENTS

As a service to you, our team of Product Specialists will work together with you and your Occupational Therapist to assess your requirements, free of charge and in the privacy of your own home. This is so you can be sure that the product is just right for you.

TOTAL CONTROL WITH NO CALL OUTS

THERE'S NO NEED FOR AN ENGINEER, YOU CAN CONTROL ALL SETTINGS WITH THE REMOTE CONTROL OR THE **AQUACLEAN APP**

Spray functionality with comfort settings that can each be individually set to five levels.

Three user profiles can be saved individually.

Option to make individual settings with the display on the rear side.

1. Start/stop shower
2. Spray intensity
3. Spray arm position/ Oscillating spray
4. Lady shower
5. Dryer
6. Flush actuation
7. User profiles (1-3)

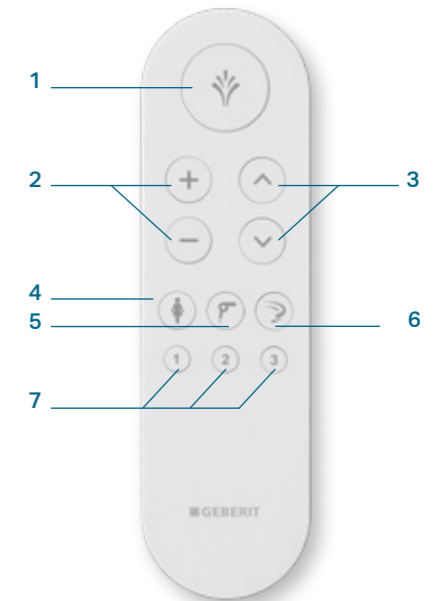

With our new App, you can personalise your comfort levels to suit your individual preferences. It's compatible with the Geberit AquaClean Mera Care shower toilet and also includes access to helpful short videos to help you improve your AquaClean experience. It couldn't be easier or more suited to your needs.

- Applicable on other AquaClean models in hospitality settings
- Works with IOS, Android and tablets
- Connects with Bluetooth
- Personalised settings
- Care and maintenance section, including warranty details and technical support and a remote support function
- Useful videos for the user
- Voice control of functions

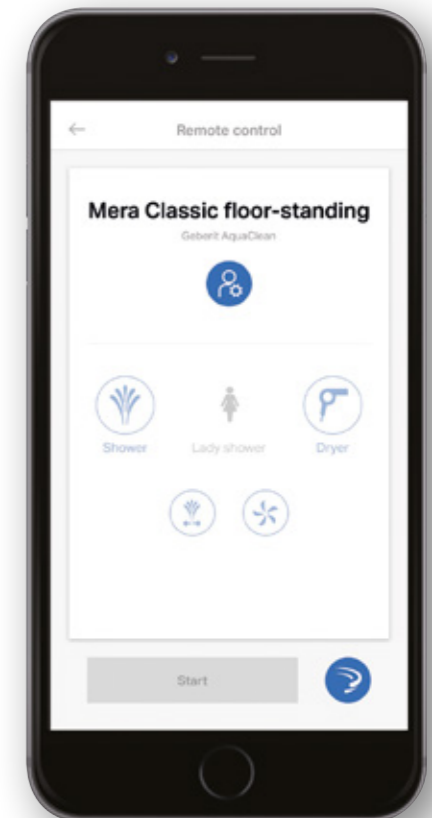

CLEANLINESS AT THE TOUCH OF A BUTTON

THE GEBERIT AQUACLEAN MERA CARE SHOWER TOILET. EXCLUSIVELY DESIGNED FOR THE CARE SECTOR

A wide range of specialised features make this the perfect toilet for the care sector, providing all the comfort, convenience, compliance you are looking for – along with enhancing quality of life and levels of independence for users.



WhirlSpray shower technology

With five adjustable shower pressure settings.



Rimless ceramic pan

With TurboFlush technology.



Your own personal well-being programme

Specify and store your unique preferences with the intuitive and clearly laid-out remote control.



Adjustable spray arm

The position of the spray arm and the intensity of the pulsating shower spray can be personalised.



Adjustable water spray temperature

Allows you to manage your preferred temperature.



Oscillating spray

The slight movement of the shower spray ensures a feeling of exceptional cleanliness.



Gentle intimate hygiene

Gentle cleaning of sensitive intimate areas with pure water.



Gentle drying

Take advantage of the gentle flow of air provided by the integrated warm air dryer.



No unpleasant odours

Powerful built-in odour extraction technology removes unpleasant smells.



Practical and easy to maintain

From the easily removable seat and lid to the automatic descaling programme, Geberit AquaClean Mera Care is specifically designed to be cleaned and maintained with minimal effort throughout its long service life.



Adjustable height

Geberit AquaClean Mera Care (with a height range of 435mm-565mm) is flexible to accommodate specific seat height requirements at installation, thanks to the in-built height adjustable stainless steel frame.



Descaling function

Available via remote control.



Continuous flow heater and storage water heater

The ability to have two warm washes one after the other with a 1 minute cleaning time.

Continuous flow heater and storage water heater

The ability to have two warm washes one after the other with a 1 minute cleaning time.

Automatic flushing via user detection

When the user sits up from the toilet seat, the flushing function operates automatically.

Flush actuation from remote control

Manual flushing can be activated by pushing the new flush button on the remote control for a full flush (6 litres).

Touchless wall control panel

Easy to activate panel with only one sensor button to start the shower program, including flush.

Shower chair mode

The shower chair mode can be switched on or off depending on the user's needs.

Fixed seat no lid

The toilet seat fittings are designed to withstand lateral forces giving the user complete peace of mind.



FEATURES EXCLUSIVE TO THE MERA CARE

GEBERIT AQUACLEAN MERA CARE HAS BEEN DESIGNED WITH YOU IN MIND. WITH ITS RANGE OF ADVANCED AND INDIVIDUALLY ADJUSTABLE FEATURES, IT IS AN IDEAL SOLUTION FOR GREATER INDEPENDENCE AT HOME.



↑ AUTOMATIC FLUSHING VIA USER DETECTION

When the user sits up from the toilet seat, the flushing function operates automatically.



↑ SHOWER CHAIR MODE

The shower chair mode can be switched on or off depending on the user's needs.



↑ MANUAL FLUSH VIA REMOTE CONTROL

Manual flushing can be activated by pushing the flush button on the remote control for a full flush (6 litres).



↑ FIXED SEAT NO LID

The enhanced toilet seat buffers are designed to withstand lateral forces.



↑ TOUCHLESS WALL CONTROL PANEL

Easy to activate panel with only one sensor button to start the shower program, including flush.

See page 22 for the full list of features and benefits

DESIGNED FOR EFFORTLESS HYGIENE

THE GEBERIT AQUACLEAN MERA CARE IS ENHANCED WITH MULTIPLE FEATURES WHICH AID EASY CLEANING AND MINIMAL MAINTENANCE

KERATECT GLAZE

The ceramic pan is covered in a special glaze called KeraTect® which creates a virtually non-porous surface that is very easy to clean. Not only does this make the surface more hygienic but also more durable and scratch proof.



ODOUR EXTRACTION

Thanks to the automatic, low-noise odour extraction unit, unwanted odours are absorbed even before they leave the ceramic pan and are eliminated by a ceramic honeycomb filter.



RIMFREE CERAMIC PAN

The Rimfree® ceramic pan ensures perfect hygiene. Thanks to its optimised water guide, the entire inner ceramic surface is completely rinsed, for much easier cleaning. Also since the pan is rimless, there are no hidden areas where deposits can build up.



ACCESSORIES SUITABLE FOR GEBERIT AQUACLEAN

QUALITY PRODUCTS FOR LONG-TERM SUPPORT

To ensure an all round comfortable experience Geberit AquaClean Mera Care can be used in conjunction with sani commode chairs and wall mounted grab rails, ensuring a feeling of well-being and offering added comfort and convenience.



SANI COMMODE CHAIRS FOR ADDED ASSISTANCE

A range of sani commode chairs are available and compatible with the Geberit AquaClean Mera Care.



WALL MOUNTED GRAB RAILS FOR ADDITIONAL SUPPORT

Grab rails provide extra support when seating and raising.

FREQUENTLY ASKED QUESTIONS

ALL YOU NEED TO KNOW

WHAT ARE THE BENEFITS?

For a more thorough and soothing clean, the gentle spray of warm water is kinder to your skin than cleaning with paper. You feel clean, rejuvenated and experience a higher level of satisfaction.

HOW DOES IT WORK?

Take a seat as a spray of warm water activates and washes you at an intensity level to suit you. As soon as you sit down, the odour extraction will be activated and finally you will be dried gently with a flow of warm air.

IS IT EASY TO USE?

Yes. Geberit AquaClean Mera Care has been designed with you in mind. It offers a variety of control options that allow you to choose whichever functions are most convenient. Even hands-free operation is included without compromising on individuality.

IS IT SUITABLE FOR PEOPLE WITH HEALTH PROBLEMS?

Yes, it is ideal for people who suffer from skin irritations in sensitive areas. This is because it cleans gently and thoroughly with fresh water. Many users find that their symptoms are considerably alleviated or even avoided.

HOW SUSTAINABLE IS IT?

Geberit AquaClean Mera Care makes the need for toilet paper obsolete. It only uses a small amount of well-directed water each time you activate the spray function. Paired with low energy consumption we have developed a feature packed shower toilet that is as sustainable as a conventional WC. Please contact us on freephone 0800 032 9629 to request a copy of our sustainability report.

CAN IT BE USED IN CASE OF A POWER CUT?

Yes it can. There is a mechanical flush button included, so you can continue using the Geberit AquaClean Mera Care as a standard toilet, should you experience a power cut.

HOW LONG IS A GEBERIT AQUACLEAN MERA CARE SHOWER TOILET LIKELY TO LAST?

In our experience, it can last up to 15 years. As with conventional toilets the lifespan of the WC will depend on how well it is maintained.

IS A LID AVAILABLE?

The Geberit AquaClean Mera lid can be added quickly and easily. The article number to order is 243.211.11.1 . Contact 01926 516 807 to make your purchase.

CAN IT BE CLEANED LIKE A CONVENTIONAL TOILET?

Geberit AquaClean Mera Care features a unique dirt-repellent finish for easy care and the highest standard of hygiene. Regular cleaning with a soft damp cloth and the Geberit AquaClean Mera Care cleaning agent, is recommended to keep the shower toilet in good condition.

WHO CAN INSTALL THE PRODUCT?

We were keen to develop a product that's innovative and easy to install. As a result, any qualified installer of your choice will be able to carry out the job.

WHERE CAN I PURCHASE OPTIONAL EXTRAS?

If you require an optional extra such as grab rails or a toilet lid, these must be purchased separately contact us on freephone 0800 032 9629.

WHO ARE GEBERIT?

Geberit is the European market leader in sanitary technology. Since its founding in 1874, the company has been a pioneer in the industry and continuously thrives on its Swiss precision and engineering. Geberit is recognised for producing state of the art products renowned for their endurance and cutting edge design.

The product range includes sanitary and plumbing systems, and ceramics. Geberit products are innovative, durable and ecologically efficient. The main production sites are situated in Switzerland, Germany and Austria.

→ www.geberit-aquaclean.co.uk/care

WARRANTY

PROVIDING PEACE OF MIND

Geberit is known worldwide for products of exceptional quality and design. That's why we offer a five year parts and labour warranty as standard. This is our promise to you.

Once your new Geberit AquaClean Mera Care has been installed, you can register it online by visiting:

→ www.geberit-aquaclean.co.uk/care

Or simply contact us on freephone:

→ **0800 032 9629**

When you have registered your product, any spare parts used by a service engineer and the labour to resolve a manufacturing defect or fault, will be supplied free of charge, for a total of five years.

5 years parts and labour guarantee



DEPEND ON INDEPENDENT EXPERTISE

OUR DEDICATED TEAM HAVE MANY YEARS OF
EXPERIENCE IN CARE AND ARE HERE TO HELP

For more information contact us at: aquaclean.uk@geberit.com



ADVICE AND SERVICE

A FULL RANGE OF SERVICES FOR YOU

We are sure that you will be delighted with Geberit AquaClean Mera Care. If you require technical, product or sales support, our team of advisors will be pleased to assist you.

DEDICATED TEAM OF TECHNICAL EXPERTS

We have a skilled team of expert technicians based across the UK, so you can expect quality after sales support and be confident that your Geberit AquaClean Mera Care will operate at its best for years to come.

Should you have any technical queries regarding Geberit AquaClean Mera Care, simply contact our technical team on 01926 516 800, who will be happy to advise you.

HELPING YOU TO GET THE MOST OUT OF YOUR PRODUCT

Once installed the Geberit AquaClean Mera Care is very easy to use. However, if you would like to book a complimentary product training session, our Product Specialists will only be too happy to help. Contact us on freephone 0800 032 9629 to make an appointment.

CONSUMABLES

To purchase a new filter or consumables including cleaning agent for your Geberit AquaClean Mera Care, contact our Spares Direct Hotline on 01926 516807. Lines are open Monday to Thursday 8:00am - 5:30pm and Fridays 8:00am - 4:00pm.



RESOURCES

VIDEO

For more help and information on the installation of your Geberit AquaClean Mera Care shower toilet, please visit:

Visit: www.geberit.co.uk/services/video-centre/

Or to see more demonstrative videos visit the Geberit Youtube channel: www.youtube.com/GeberitGroup

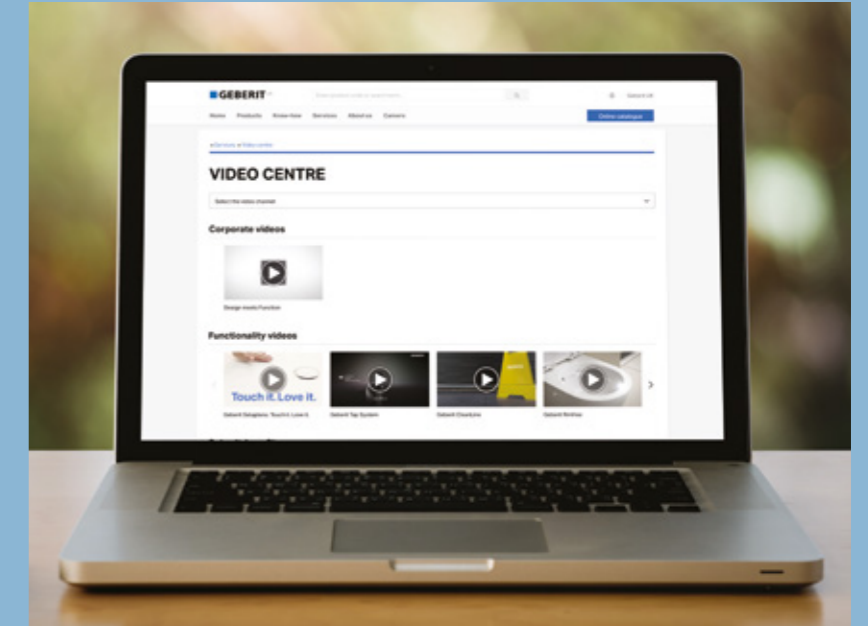

APPS

To register your Geberit AquaClean Mera Care warranty download the end user App from the app store.

IOS

Download the Geberit Home App for iPhone and iPad



ANDROID

Download the Geberit Home App for Android

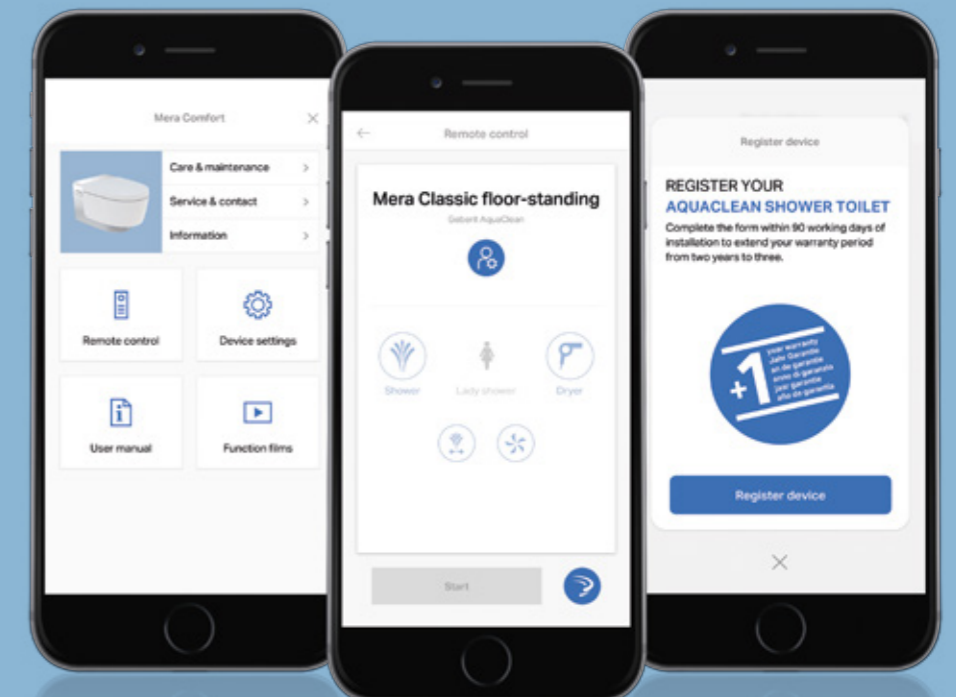

FEATURES AT A GLANCE

DESIGNED WITH YOU IN MIND



FUNCTION	BENEFIT
WhirlSpray shower technology	Provides a comfortable clean whilst saving water
Oscillation function	Forwards and backwards spray arm motion
Adjustable shower arm	To suit your seating position
Separate lady shower nozzle in protected home position	Activates on request for gentle cleansing with fresh water
Adjustable water temperature	Select a temperature that is right for you
Continuous warm water heater	For maximum showering comfort
Fan dryer	Fully extendable with unlimited programme duration to suit you
Odour extraction with a ceramic honeycomb filter	To neutralise odours
SoftClosing WC seat	Inhibits seat slamming to prevent accidents
QuickRelease function for WC seat	For easy cleaning
TurboFlush technology	Toilet is flushed thoroughly and quietly
Rimfree® WC pan with dirt-repellent ceramic	Nowhere for germs to hide
Remote control	Easy-to-operate, ergonomically designed
End user app	Control your AquaClean with your app
User detection	Recognises user on toilet
Descale function	Indicates when descaling is required
Touchless control panel	Touch-free activation of wash, dry and flush
Programmable user profiles	Control can store up to 4 settings

TECHNICAL INFORMATION

EASY TO INSTALL, EVEN IN WET ROOMS



Product code	146.242.11.1
Colour	White
Protection class	I
Protection degree	IPX4
Nominal voltage (V)	230 V AC
Mains frequency (Hz)	50 Hz
Power consumption (W)	2000 W
Power consumption standby (W)	≤ 0.5 W
Flow pressure (bar)	0.5–10 bar
Flow pressure (kPa)	50–1000 kPa
Operating temperature (°C)	5–40 °C
Water temperature, adjustment range (°C)	34–40 °C
Flush volume, factory setting (l)	6 and 4 l
Air volume flow rate, dryer (m³/h)	6 m³/h
Air volume flow rate, odour extraction (m³/h)	6 m³/h
Calculated flow rate (l/s)	0.03 l/s
Flow rate, anal shower (l/min)	1.1–2.0 l/min
Minimum flow pressure for calculated flow rate (bar)	0.5 bar
Flow rate, lady shower (l/min)	0.4–0.7 l/min
Minimum flow pressure for calculated flow rate (kPa)	50 kPa
Washing time per activation	30–50 s
Maximum load WC seat	30 stone

Geberit AquaClean Mera Care must be connected to a mains water supply

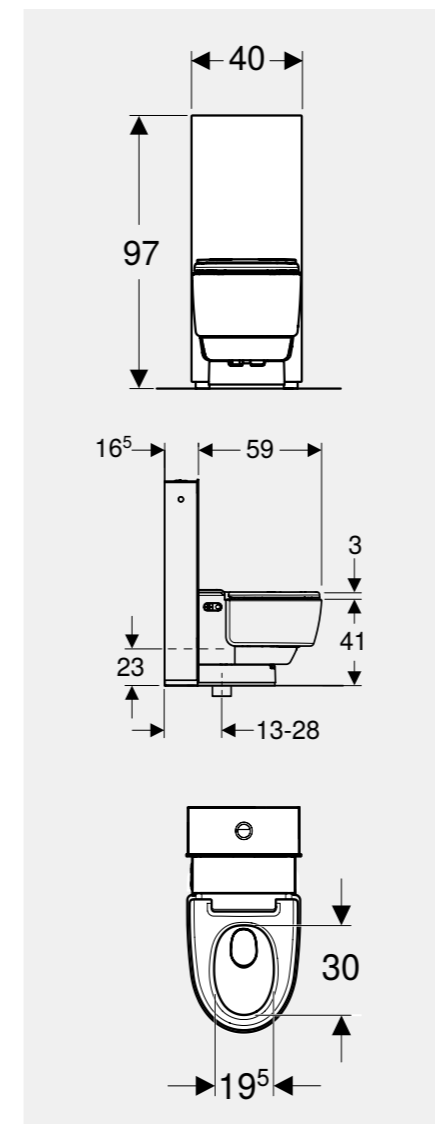

SPECIFICATION SHEET

GEBERIT AQUACLEAN MERA CARE
THE TOILET THAT CLEANS YOU WITH WATER

STANDARD SPECIFICATION:

- Strengthened seat
- Touchless remote control
- User remote control
- Lady wash
- Oscillating spray
- Weight limit of 30 stone
- Self-servicing function
- Height adjustable frame
- Compatible with end user app
- 5 year warranty (requires free registration)

5 YEAR WARRANTY

FREE 5 years parts and labour when you register your product within 90 days
geberit-aquaclean.co.uk/care



SEAT HEIGHT OPTION

Adjustable from 435mm and 565mm at installation

OPTIONAL EXTRAS

- Customer requirements
- Seat lid (not advisable for side transfers, hoisting or shower chairs)

→ For additional information or advice contact:



↑ TOUCH-FREE OPERATION

↑ PERSONALISED COMFORT

↑ TOTAL CONTROL

↑ ADJUSTABLE HEIGHT

→ For additional information or advice contact:

Geberit Sales Ltd. Geberit House, Edgehill Drive, Warwick, Warwickshire CV34 6NH.
T 01926 516800. E enquiries@geberit.co.uk
→ www.geberit-aquaclean.co.uk/care

GEBERIT AQUACLEAN MERA CARE

SPECIFICATION SHEET

Geberit Sales Ltd
Geberit House
Edgehill Drive
Warwick
CV34 6NH

T 0800 032 9629

www.geberit-aquaclean.co.uk/care

